

OUR CORNERSTONE



In addition, we have a full line of sterile animal sera plus a complete line of agamma* sera that includes bovine, calf, chicken, horse, human, lamb and rabbit--and the finest in liquid media, powdered media, cells, balanced salt solutions, chromosome kits, mycoplasma and "T" strain agar and broth for the isolation of Mycoplasma sp.

*Alcohol Fractionated To Remove The Gamma Globulin;
U. S. Patent No. 3,122,476

WRITE FOR OUR LATEST CATALOG TODAY. . .

NORTH AMERICAN BIOLOGICALS, INC.

12601 Twinbrook Parkway
Rockville, Maryland 20852
(301) 881-8931

13323 South Normandie Avenue
Gardena, California 90249
(213) 321-3991

INCUBATORS *for* **professional use**

- **Dry or Humid**
- **CO₂**
- **Refrigerated**

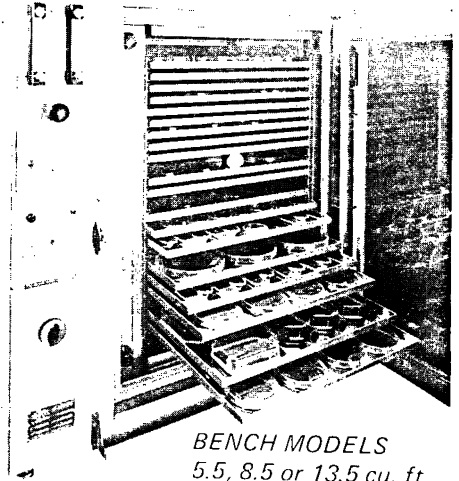

*BENCH MODELS
5.5, 8.5 or 13.5 cu. ft.*

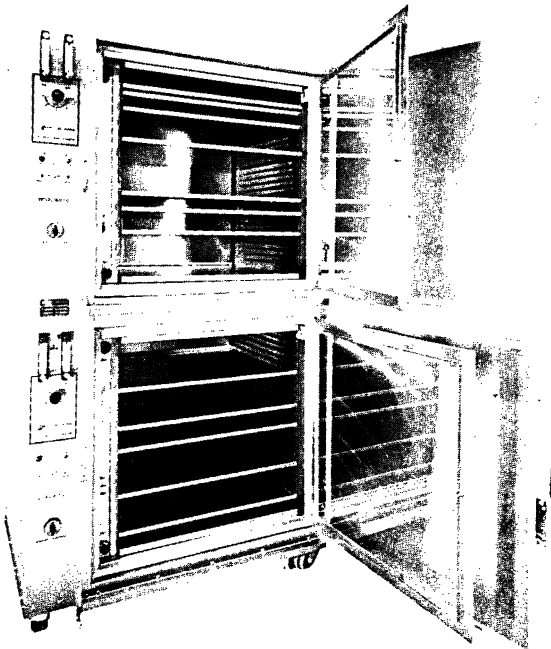

- *High Loading Capacity*
- *Laminar Flow Circulation*
- *Fast Recovery*
- *All Stainless Steel*
- *Low CO₂ Consumption*

*DUAL CHAMBER FLOOR MODELS
SEPARATE CONTROLS
17 & 27 cu. ft.*

FOR ADDITIONAL INFORMATION WRITE:

W E D C O

**INC., CUSTOMER SERVICE DEPT., P. O. BOX 223
SILVER SPRING, MARYLAND TEL. (301) 589-9450**

BIOLOGICAL EFFECTS OF POLYNUCLEOTIDES

Edited by Robert F. Beers, Jr., Johns Hopkins University, Baltimore, MD. Werner Braun, Rutgers, The State University, New Brunswick, N.J.

xvi, 344 pp. 105 illus. Cloth. 1971. \$24.00
ISBN 0-387-05345-X

The non-informational role of polynucleotides in biological processes has received increased attention during the past few years and is reflected in the content of this symposium.

The purpose of this 1970 symposium sponsored by Miles Laboratories, was to bring together investigators studying the interferon induction and adjuvant properties of polynucleotides with particular emphasis on their possible clinical applications in veterinary and human medicine as anti-viral and anti-tumor agents. The importance of other pharmacological toxic effects as well as their possible messenger roles have also been emphasized in order to provide a forum for evaluating the potential usefulness of these agents in preventive and therapeutic medicine.

SPRINGER-VERLAG NEW YORK INC.
175 Fifth Ave., New York, N.Y. 10010

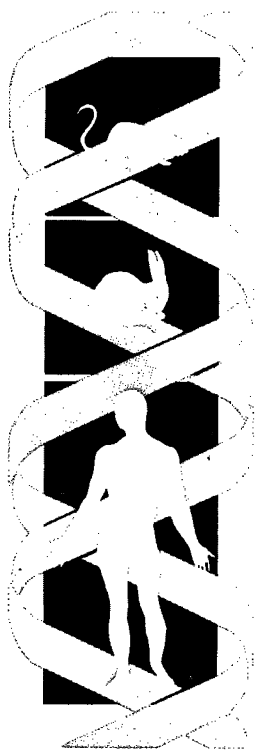

MANUAL OF CLINICAL MICROBIOLOGY

Edited by JOHN E. BLAIR, Department of Microbiology, The Roosevelt Hospital, New York; EDWIN H. LENNETTE, Viral and Rickettsial Disease Laboratory, California Department of Public Health, Berkeley; and JOSEPH P. TRUANT, Department of Microbiology, Providence Hospital, Southfield, Michigan. With an expert editorial board of 16 members. *Regular edition: \$12.00; student edition: \$7.00.* Published by the American Society for Microbiology. Members of the Society may purchase copies of the regular edition at a 50% discount from the ASM Publications Office, 1913 I Street, N.W., Washington, D.C. 20006.

This manual is designed to be used as a working reference guide in clinical microbiology for the teacher and technologist. It encompasses the fields of clinical bacteriology, mycology, virology, and parasitology. Currently accepted and proven methods are presented which permit the complete microbiological examination of clinical specimens. Procedures are given for the isolation and identification of the medically important bacteria, fungi, viruses, and parasites, with emphasis on those organisms which occur most frequently in infection in man, but with adequate consideration of the rarer forms.

General sections describe the collection and processing of specimens, nutritive and environmental requirements of microorganisms, selection and inoculation of culture media for primary isolation, quality control, formulas of culture media, reagents and stains, and staining procedures.

1970

704 pages

WILLIAMS & WILKINS, 428 E. Preston St., Baltimore, Md. 21202

A grand opening for a closed system

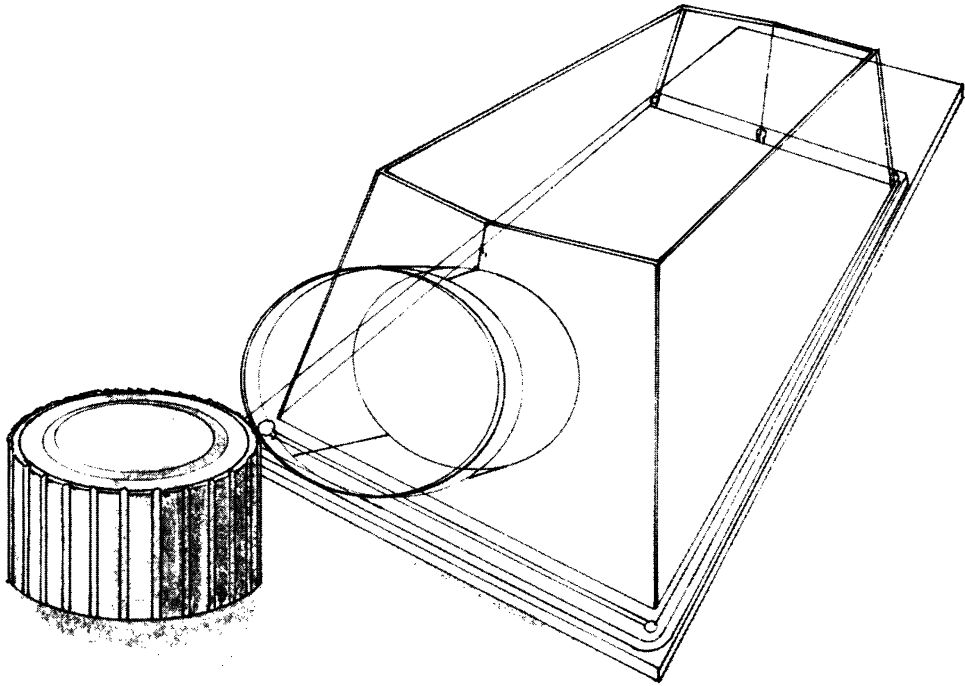

LAB-TEK® FLASKETTE™ biological growth chamber

Here's a flask with a different slant: it's actually a micro growth chamber with an exclusive tilt-neck design for easier access to cells. For tissue culturing, the large 0.9 cm. dia. neck opening allows exceptional manipulation of a 5 ml. pipette. Flaskette offers the recognized advantages of a closed system, but eliminates the need for bulky equipment or large amounts of reagents, etc. The unique design also prevents spillage and greatly reduces the risk of contamination since residue left in the tilt-neck will flow back into the flask. Flaskette can serve either as a test chamber or as a mini-sized stock bottle. Its small size saves space

both in the incubator and on the workbench.

Flaskette is non-toxic, optically clear, sterile and comes ready to use. And once the plastic chamber and gasket are removed, the standard glass slide is a permanent record of testing. A bonus: the glass slide also allows cells to be fixed with acetone once the plastic components are removed.

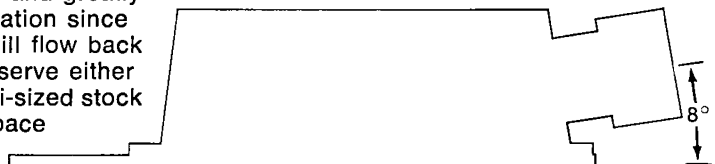

For the full story, call your
LAB-TEK Representative, or write:

Lab-Tek Products

LAB-TEK Division Miles Laboratories, Inc.
30W475 N. Aurora Rd., Naperville, Illinois 60540

LAB-TEK® Flaskette™ #4820 features tilt-neck design. Actual size: 13/16" x 1" x 3-7/16". Total volume: 16 ml; suggested working volume: 5 ml. Self-sealing cap is non-toxic. Flaskette is available in packages of 16, with two trays of 8 each from your LAB-TEK Distributor.



Now... Clearest Tissue Culture Sera

Difco TC Sera is prepared using a unique method of freeze drying. This new process provides precipitate free sera with optimum clarity when rehydrated. With this method, there is no loss of growth promoting factors.

SPECIAL STORAGE OR SHIPPING NOT REQUIRED. Maximum stability assured—no deterioration when properly stored at 2 - 8C.

Difco was first to offer dry TC media. Our extensive line and packaging of liquid and dry tissue culture media, sera and reagents has been supplied to laboratories for over 20 years. These products are mycoplasma free and fulfill the requirements of any tissue culture laboratory.

Write for literature number 0140.

LABORATORIES
DETROIT MICHIGAN U.S.A.

International Journal of Systematic Bacteriology

Volume 21 (4) October 1971

*Absolutely essential to those who must keep
abreast of the ever-changing field of bacterial
systematics*

EDITORIAL BOARD

Erwin F. Lessel, Editor; H. P. R. Sceliger; V. B. D. Skerman, Chairman

Designation of Type Strains for <i>Bifidobacterium</i> Species. G. REUTER.....	273
Deoxyribonucleic Acid Homology Relationships Among Species of the Genus <i>Bifidobacterium</i> . V. SCARDOVI, L. D. TROVATELLI, G. ZANI, F. CROCIANI, and D. MATTEUZZI.....	276
Theoretical Deoxyribonucleic Acid Homology Between Strains in <i>Rhizobium japonicum</i> . GERALD H. ELKAN and RICHARD A. USANIS.....	295
<i>Eubacterium lentum</i> (Eggerth) Prévot 1938: Emendation of Description and Designation of the Neotype Strain. W. E. C. MOORE, ELIZABETH P. CATO, and LILLIAN V. HOLDEMAN.....	299
<i>Eubacterium contortum</i> (Prévot) comb. nov.: Emendation of Description and Designation of the Type Strain. LILLIAN V. HOLDEMAN, ELIZABETH P. CATO, and W. E. C. MOORE.....	304
<i>Eubacterium aerofaciens</i> (Eggerth) Prévot 1938: Emendation of Description and Designation of the Neotype Strain. W. E. C. MOORE, ELIZABETH P. CATO, and LILLIAN V. HOLDEMAN.....	307
Transfer of <i>Sarcina</i> Goodsir from the Family <i>Micrococcaceae</i> Pribram to the Family <i>Peptococcaceae</i> Rogosa. MORRISON ROGOSA.....	311
Relationship of <i>Micrococcus</i> sp. ATCC 407 to the Status of <i>Micrococcus freudenreichii</i> Guillebeau. I. J. McDONALD.....	314
Serological Investigations of <i>Planococcus</i> Strains. PER OEDING.....	323
<i>Streptomyces clavuligerus</i> sp. nov., a β -Lactam Antibiotic Producer. C. E. HIGGENS and R. E. KASTNER.....	326
Taxonomy of the Chlamydiae: Reasons for Classifying Organisms of the Genus <i>Chlamydia</i> , Family <i>Chlamydiaceae</i> , in a Separate Order, <i>Chlamydiales</i> ord. nov. JOHANNES STORZ and LESLIE A. PAGE.....	332

Published Quarterly

ASM Publications Office
1913 I St., N.W.,
Washington, D.C. 20006

Please enter my subscription to the INTERNATIONAL JOURNAL
OF SYSTEMATIC BACTERIOLOGY.

Check one:

____ Institution (\$12)

____ Personal (\$8)

Name _____

Address _____

City/State/Zip _____

SPORES V

Edited by

HARLYN O. HALVORSON, RICHARD HANSON, AND
L. LEON CAMPBELL

A publication comprising the papers presented at the Fifth International Spore Conference, held at Fontana, Wisconsin, 8-10 October 1971.

This book contains reviews as well as reports of original and basic research in eight related areas of interest regarding spores.

1. Structure and chemical nature of spores.
2. Genetics of spore forms.
3. Biochemical changes during sporulation:
Sporulation-related events.
4. Regulation of macromolecular synthesis during
sporulation and outgrowth.
5. Ecology of spore forms.
6. Immunology of spores and spore forms.
7. Cryptobiosis: Dormancy and its alterations.
8. Biochemical mechanisms of germination.

This book will serve as a valuable resource book for investigators, teachers, students, industry, and libraries.

1972

471 pages

\$10*

Publications Office
AMERICAN SOCIETY FOR MICROBIOLOGY
1913 I St., N.W.
Washington, D.C. 20006

* Members of ASM are entitled to purchase copies for personal use at the member price of \$5 per copy.

ANNOUNCING . . .

ANTIMICROBIAL AGENTS AND CHEMOTHERAPY

a new monthly publication of the American Society for Microbiology

editors

Editor-in-Chief

Dr. Gladys L. Hobby, Scientific Director, Infectious Disease Research Institute, East Orange, New Jersey

Editors

Dr. Walter D. Celmer, Research Manager, Medical Research Laboratories, Pfizer Inc., Groton, Connecticut

Dr. Joel G. Flaks, Associate Professor of Biochemistry, University of Pennsylvania School of Medicine, Philadelphia

Dr. Edward W. Hook, Professor and Chairman, Department of Medicine, University of Virginia School of Medicine, Charlottesville, Virginia

Dr. Leon H. Schmidt, Associate Director of Chemotherapy Research, Southern Research Institute, Birmingham, Alabama

It is characteristic of the progress. . .

of science that new knowledge in a particular field of study fosters greater interest which, in turn, is followed by further discovery. This is the spiral of scientific progress and, sooner or later, the new information being acquired demands a regular medium for communication.

This has now happened with research in the field of antimicrobial agents and chemotherapy. Up until recently, the American Society for Microbiology's annual publication kept up with major activity in the field. But new advances in the area are now too numerous to be adequately presented only once a year. Consequently, beginning in January 1972, the Society will publish a monthly interdisciplinary journal devoted to the dissemination of knowledge relating to all aspects of antimicrobial agents and chemotherapy, including cancer chemotherapy.

PROPOSED SECTION HEADINGS

Chemistry

Biology and Experimental Infections

Mechanisms of Action and Resistance

Pharmacology

Clinical Efficacy

VOLUME 1 • JANUARY 1972 • NUMBER 1

Antimicrobial Agents and Chemotherapy

Published by the American Society for Microbiology



It is characteristic of Science and Progress that they continually open new fields to our vision — PASTEUR

PUBLISHED MONTHLY
By the American Society for Microbiology

Copyright © 1971, American Society for Microbiology
Member of the American Society of Microbiologists

SUBSCRIPTION RATE *

\$40 per year (U.S.).

\$41 per year (foreign)

For your subscription write:
Publications Office
American Society
for Microbiology
1913 I St., N.W.
Washington, D.C. 20006

* Members of ASM may receive the new journal as "part of their dues" and should subscribe when paying their annual dues

POWDERED MEDIA + PHENOL RED - H₂O = WHITE

K. C. BIOLOGICAL uses only the finest available reagents in the preparation of powdered tissue culture media. Our extensive production techniques produce an ultra dry product, as evidenced by the absence of the characteristic phenol red color. An ultra-dry product will give long shelf life and increased solubility. Write for our catalog.



KC Biological, Inc.

P. O. BOX 5441, 9900 Pflumm Road
Lenexa, Kansas 66215

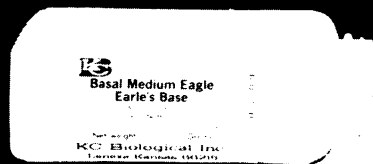

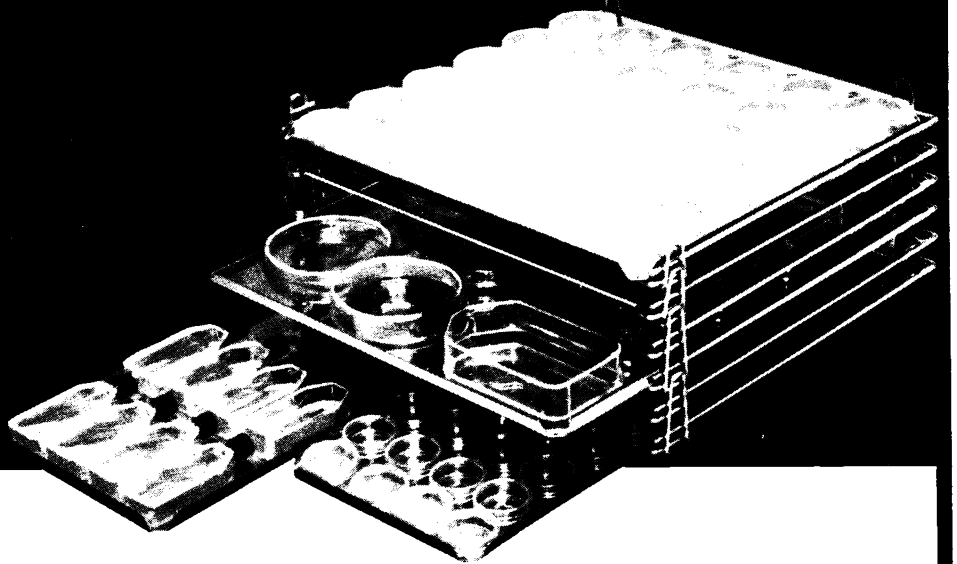

STAK A TRAY

Saves Time. Space.
Trouble
Speeds Up Laboratory
Efficiency

Revolutionizes the utilization of incubator space in Tissue Culture, Microbiology, Bacteriology and Virology laboratories. No more struggling with culture dishes and trays. No more worries about safe handling of infectious cultures. **STAK A TRAY** provides a means of organizing flasks and plates allowing for easy movement of cultures from laboratory shelf to incubator and back. There is a more efficient way of handling and storing your cultures — and **STAK A TRAY** is it.

For complete information, write for our brochure.

MICROBIOLOGICAL ASSOCIATES

SUBSIDIARY OF DYNASCIENCES CORPORATION

4733 Bethesda Avenue, Bethesda, Maryland 20014 (301) 654-3400

503 San Pablo Avenue, Albany, California 94706 (415) 526-6228

Serving the Biomedical Field Since 1947

